

Riten[®] Specials (cont.)

BULL NOSE DEAD CENTER

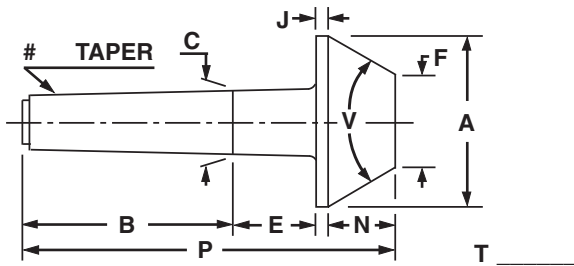

_____ TAPER A _____ B _____ C _____
 E _____ F _____ J _____ N _____ P _____ V _____

PIPE NOSE DEAD CENTER

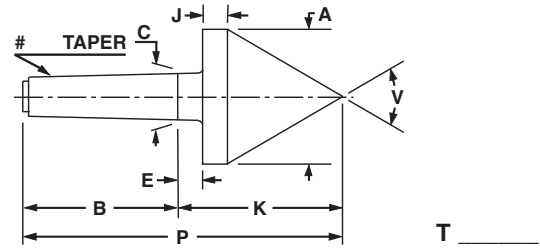

_____ TAPER A _____ B _____ C _____
 E _____ J _____ K _____ P _____ V _____

MILL TAPER DEAD CENTER

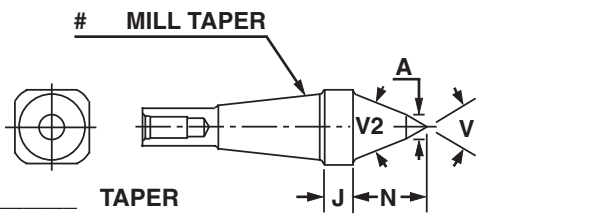

_____ TAPER A _____ J _____ N _____ V _____ V2 _____

MILL TAPER DEAD CENTER

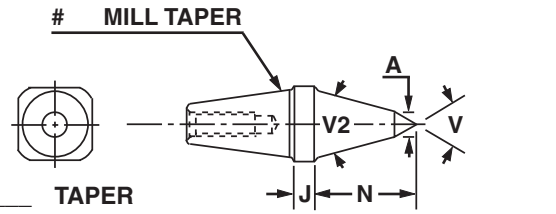

_____ TAPER A _____ J _____ N _____ V _____ V2 _____

FLANGE CENTER

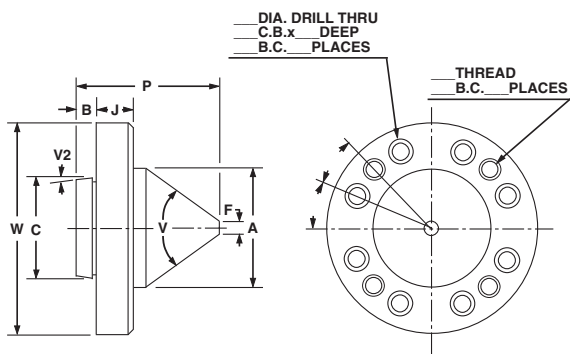

A _____ B _____ C _____ F _____ J _____
 P _____ V _____ V2 _____ W _____

_____ DIAMETER DRILL THRU
 _____ C. B. X _____ DEEP
 _____ B. C. _____ PLACES
 _____ THREAD _____ B. C. _____ PLACES

INTERCHANGEABLE POINT DEAD CENTER & SPECIAL POINT

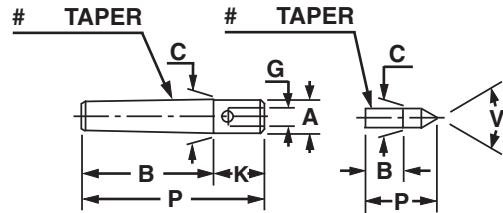

DEAD CENTER # _____ TAPER A _____
 B _____ C _____ G _____ K _____ P _____
 SPECIAL POINT # _____ TAPER
 B _____ C _____ P _____ V _____

SLEEVE WITH TANG

SLEEVE

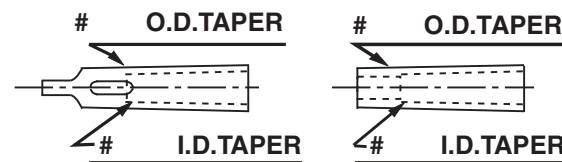

FILL IN NUMBERS ON DIAGRAM